



1400 Data Sheet



SERIES: 1000 WOOD GRILLES

STYLE: 1400 DOWEL/CROSS PIECE GRILLE

Overview

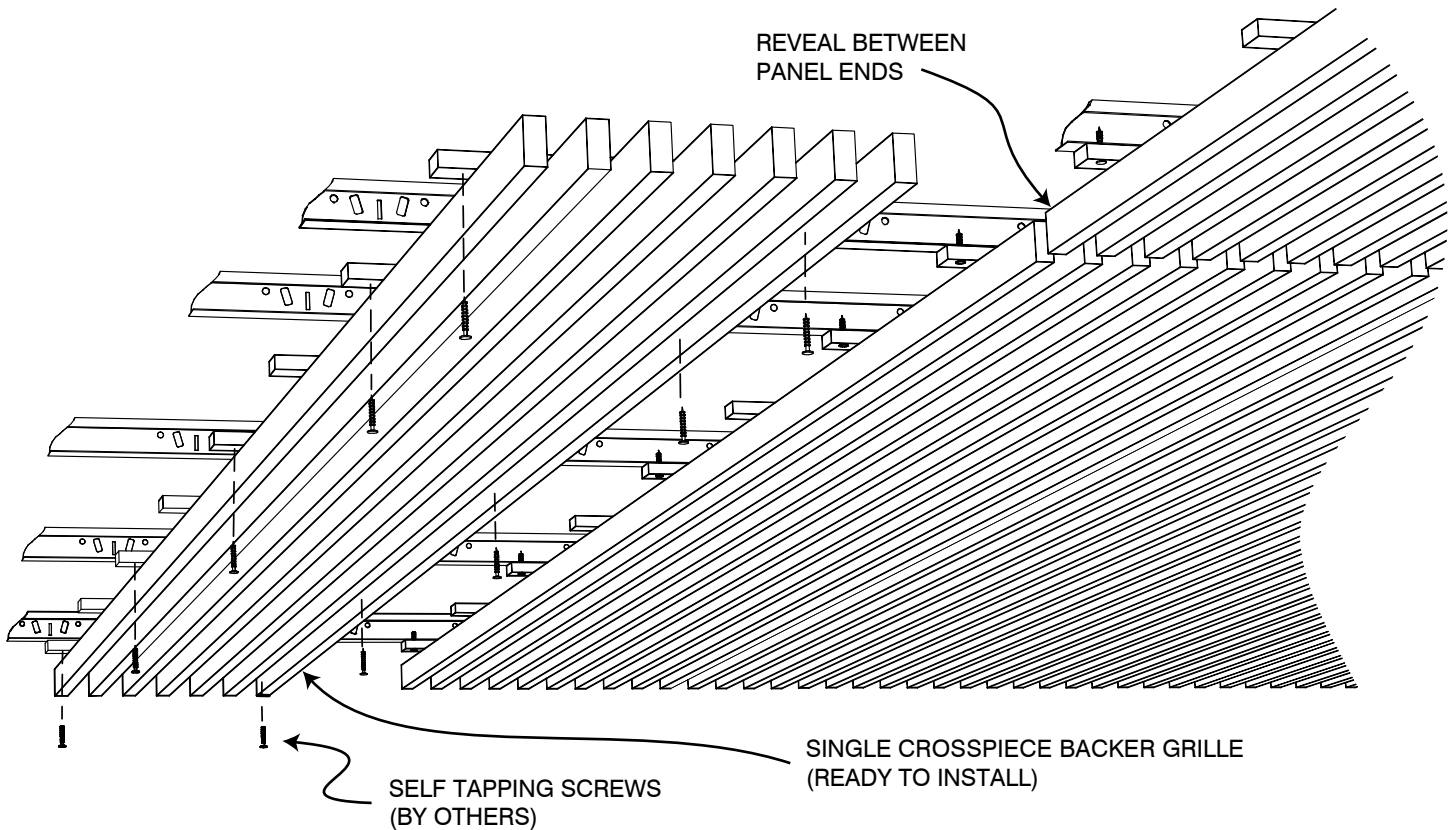

The **9Wood Dowel/Cross Piece Grille** wood ceiling offers a design where the individual wood member is deeper than it is wide. Panel width is typically 12", with backers direct-attached to T-Bar main runners every 2'. See page 3 for typical member sizes and SKUs.

Attachment for the Dowel/Cross Piece Grille is via screws fastened directly through the supplemental backer into standard T-Bar grid. This provides basic accessibility for each panel.





1400 Data Sheet



SERIES: 1000 WOOD GRILLES

STYLE: 1400 DOWEL/CROSS PIECE GRILLE

Product Data

Application

The Dowel/Cross Piece Grille uses a preassembled panel fabrication process. This product can be installed throughout the country and is a preferred design in areas requiring seismic compliance. Full panel access is available by means of removing attachment screws hidden in reveals. Repetitive removal may require threaded bolt attachment as opposed to screws.

Performance

Acclimatization

Dowel/Cross Piece Grilles must be cared for in a controlled interior environment (RH 25%-55% max; temp. 60°-80°) and installed only after reaching equilibrium moisture content. Should the building fall outside these limits consult 9Wood, Inc. for our 3 Tests/3 Tracks Acclimatization Advisory.

Acoustics

The Dowel/Cross Piece Grille can enhance acoustics via soundabsorbing material placed over open reveals within the T-Bar grid. Insulation is typically provided locally.

Fire Rating

Individual members and components can be treated with Class I (A) Fire Retardant chemicals (solid wood use FR coatings, veneered particleboard use FR formulas). Particular species or styles have not been tested.

LEED

Dowel/Cross Piece Grilles may qualify toward MR-3, MR-4.1/4.2, MR-5.1/5.2, MR-6, MR-7, IEQ-4.2 or IEQ-4.4. As all products are custom-fabricated, LEED credit opportunities are project by project. Please contact 9Wood, Inc. for specifics.

MEP

The Dowel/Cross Piece Grille permits MEP penetrations in the ceiling's surface. Cut panels may require supplemental reinforcement. Fixtures and diff users must be independently supported.

Seismic

Dowel/Cross Piece Grilles provide seismic code compliance by means of mechanical direct screw attachment to T-Bar via the cross-piece backer. Please consult local code or a licensed engineer for any additional requirements.

Species & Finishes

9Wood can offer both domestic and imported species for the Dowel/Cross Piece Grille. Clear, satin sheen finish is standard; custom stain matches are available.

Suspension

Dowel/Cross Piece Grilles are directly attached to 15/16" heavy duty T-Bar main runners. Main runners are typically 2' on center.

System Weight

Dowel/Cross Piece Grilles typically weigh 2-4 pounds per square foot, depending on members per linear foot and species.



1400 Data Sheet



SERIES: 1000 WOOD GRILLES

STYLE: 1400 DOWEL/CROSS PIECE GRILLE

Typical Specifications

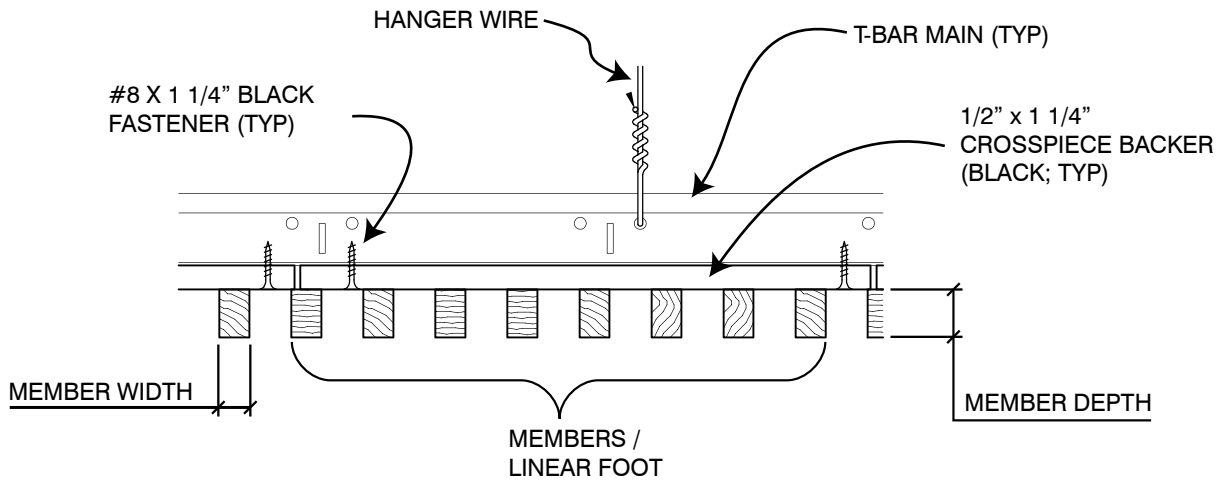

SKU Table

Width (Softwood)	Width (Hardwood or Veneer)	Depth	Grille Members per Linear Foot								
			2	3	4	5	6	7	8	9	10
5/8"	3/4"	1 3/8"	1412-2	1412-3	1412-4	1412-5	1412-6	1412-7	1412-8	1412-9	1412-10
5/8"	3/4"	2 1/4"	1413-2	1413-3	1413-4	1413-5	1413-6	1413-7	1413-8	1413-9	1413-10
5/8"	3/4"	3 1/4"	1414-2	1414-3	1414-4	1414-5	1414-6	1414-7	1414-8	1414-9	1414-10
1 3/8"	1 "	1 3/8"	1422-2	1422-3	1422-4	1422-5	1422-6				
1 3/8"	1 "	2 1/4"	1423-2	1423-3	1423-4	1423-5	1423-6				
1 3/8"	1 "	3 1/4"	1424-2	1424-3	1424-4	1424-5	1424-6				
1 3/8"	1 "	5 1/4"	1426-2	1426-3	1426-4	1426-5	1426-6				

* Other width, depth and M/LF combinations available. Please inquire.
 ** Please see 9wood.com for information on appropriate species selections.



1400 Data Sheet



SERIES: 1000 WOOD GRILLES

STYLE: 1400 DOWEL/CROSS PIECE GRILLE

Perimeter Conditions and Suspension

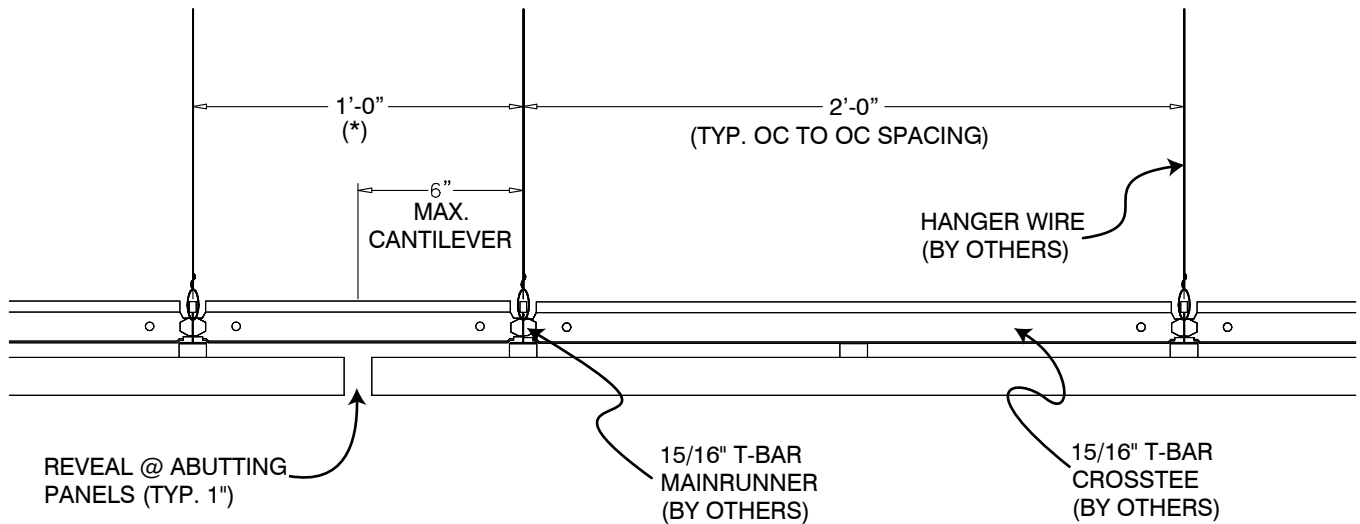

(*NOTE: A CENTER REVEAL TYPICALLY REQUIRES A CUSTOM OC SPACING IN THE SUSPENSION SYSTEM.

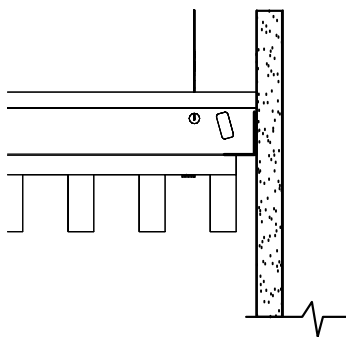

FLOATING:
OPEN REVEAL

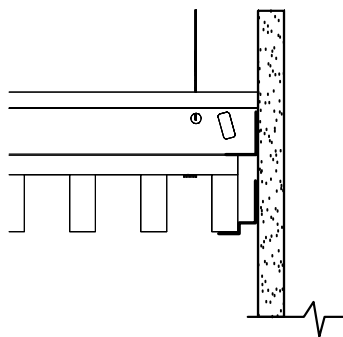

METAL TRIM:
CONT. SHADOW STYLE
WALL ANGLE

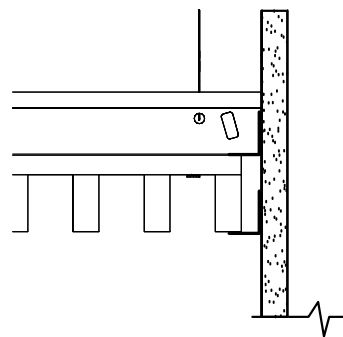

METAL TRIM:
CONT. WALL ANGLE

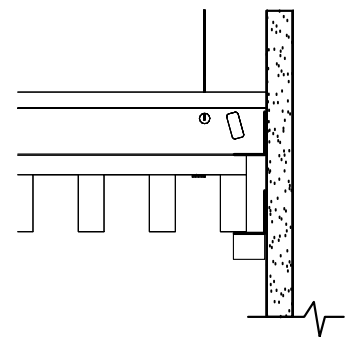

WOOD TRIM:
CONT. WALL ANGLE
W/WOOD TRIM